

All dimensions are in millimeters (mm)

Alignment Key
Front View

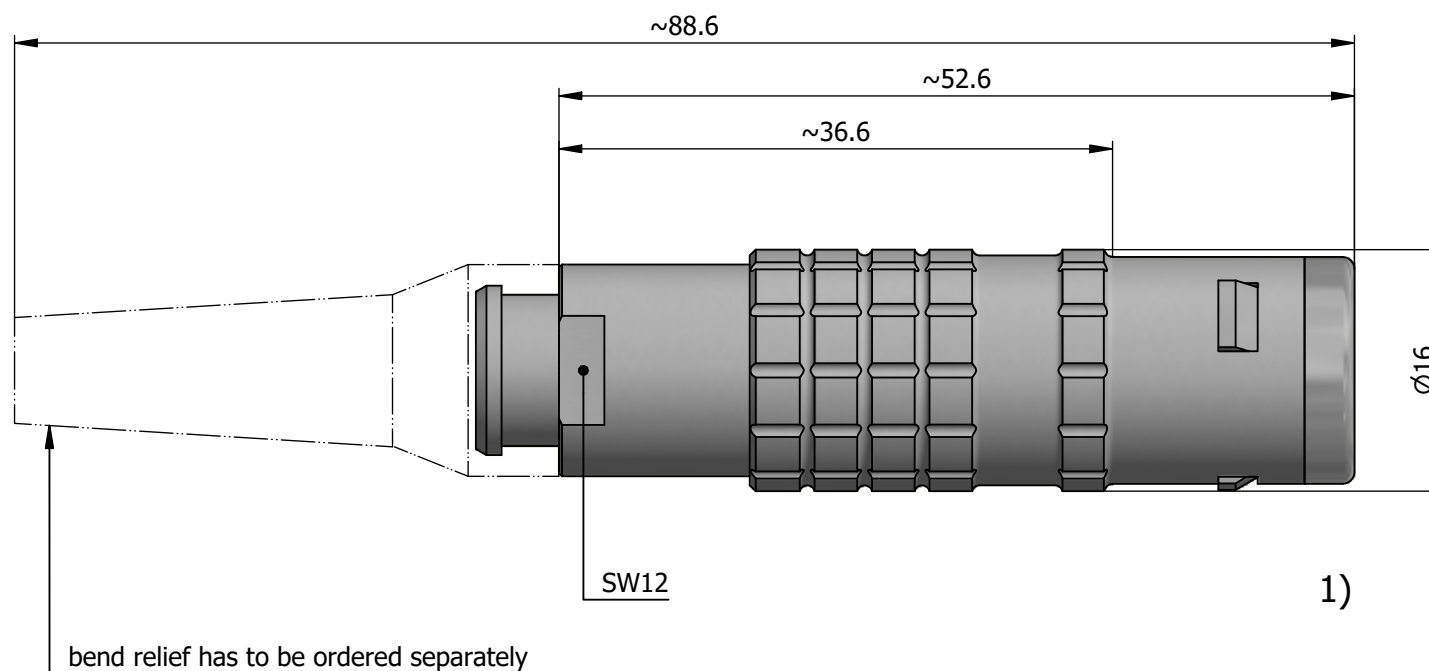

Insert Configuration
Rear View



Note:

1) This picture is generic and for illustrative purposes only, and may show different keying, materials, colour, finish, and contact configuration. Minor shape or feature variations to actual item may be present.

All additional information are documented on the datasheet (See below link or QR Code)
www.lemo.com/pdf/FFA.2E.250.CLAC80Z.pdf

Model Series Insert Config. Housing Insulator Contact Collet Type Cable Ø Variant
FFA.2E.250.CLAC80Z

Datasheet



Straight plug, cable collet and nut for fitting a bend relief

Series 2E

LEMO LEMO SA
 Chemin des Champs-Courbes 28
 1024 Ecublens - SWITZERLAND

Tel. (+41 21) 695 16 00
 email : info@lemo.com
 www.lemo.com

CD

Drawn	11.11.2024	MARI/MARI
Checked	11.11.2024	OBAR
Modified	00	11.11.2024/MARI
DO NOT SCALE DRAWING		

FFA.2E.250.CLAC80Z