

All dimensions are in millimeters (mm)

Alignment Key  
Front View

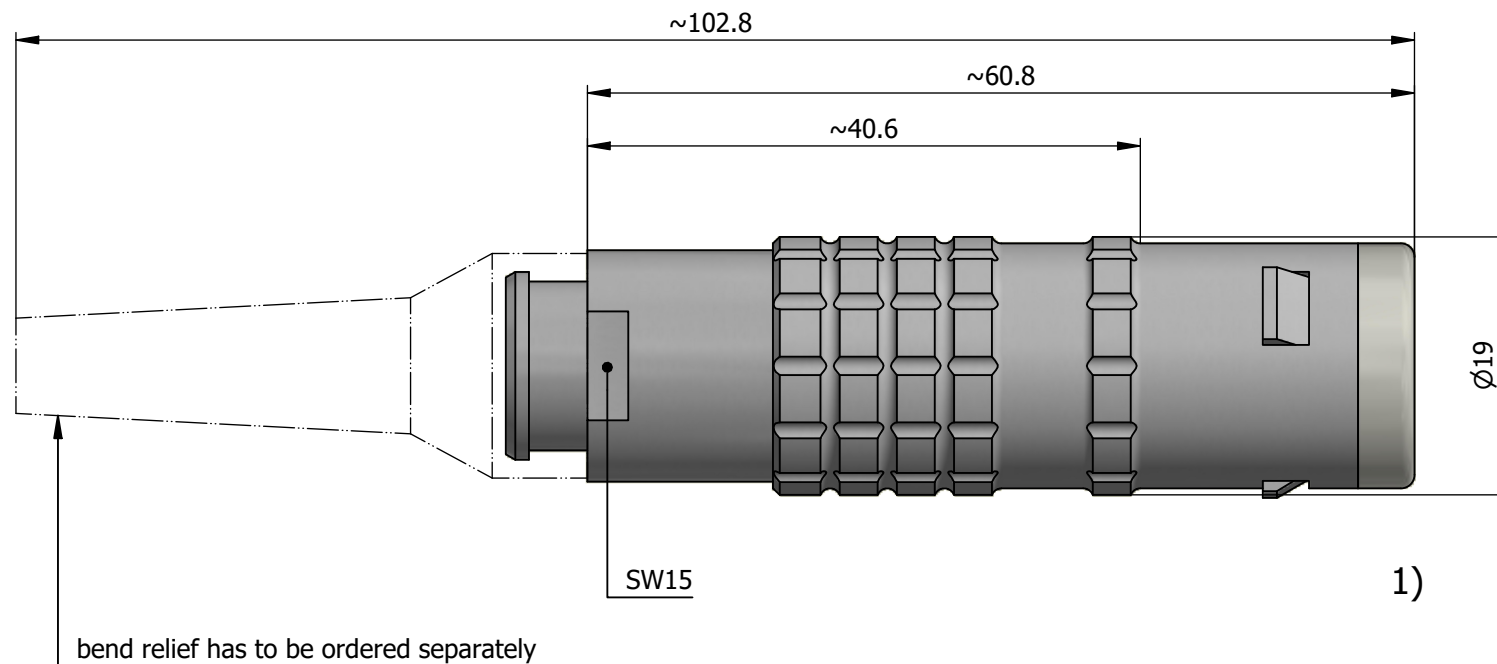

Insert Configuration  
Rear View

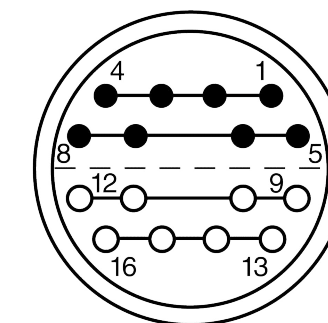

**Note:**

1) This picture is generic and for illustrative purposes only, and may show different keying, materials, colour, finish, and contact configuration. Minor shape or feature variations to actual item may be present.

All additional information are documented on the datasheet (See below link or QR Code)  
[www.lemo.com/pdf/FFA.3E.316.CLAC10Z.pdf](http://www.lemo.com/pdf/FFA.3E.316.CLAC10Z.pdf)

Model	Series	Insert Config.	Housing	Insulator	Contact	Collet Type	Cable Ø	Variant
FFA	3E	316	CLAC	10Z				

 Datasheet	<b>Straight plug, cable collet and nut for fitting a bend relief</b> Series 3E		Drawn 11.11.2024 MARI/MARI
	 LEMO SA Chemin des Champs-Courbes 28 1024 Ecublens - SWITZERLAND		Checked 11.11.2024 OBAR
	Tel. (+41 21) 695 16 00 email : info@lemo.com www.lemo.com		Modified 00 11.11.2024/MARI
	CD		DO NOT SCALE DRAWING
<b>FFA.3E.316.CLAC10Z</b>			