

All dimensions are in millimeters (mm)

Alignment Key
Front View

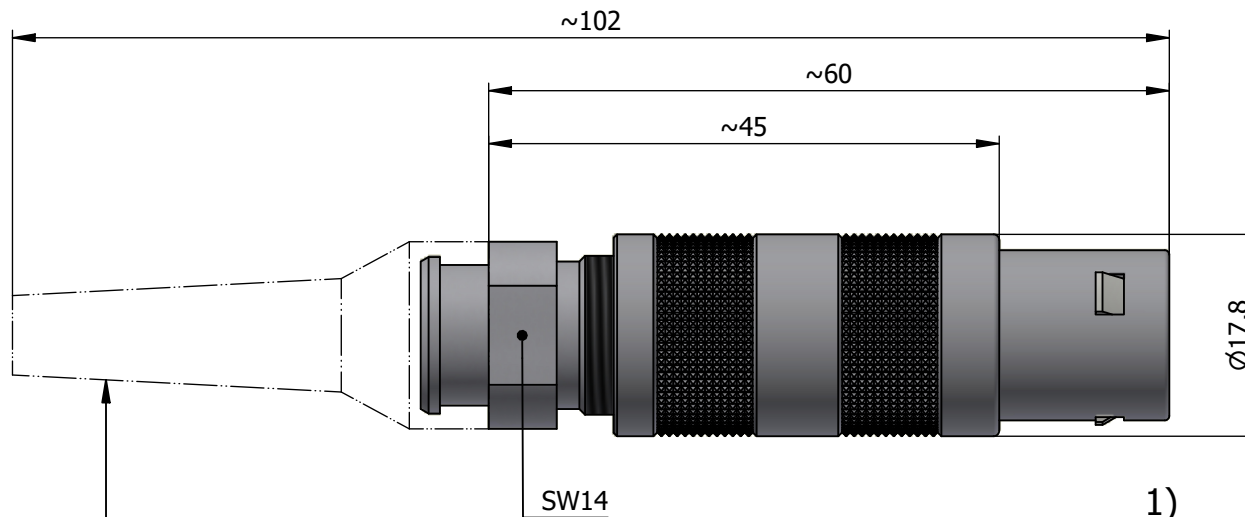

Insert Configuration
Rear View



bend relief has to be ordered separately

Note:

1) This picture is generic and for illustrative purposes only, and may show different keying, materials, colour, finish, and contact configuration. Minor shape or feature variations to actual item may be present.

All additional information are documented on the datasheet (See below link or QR Code)
www.lemo.com/pdf/FFA.3S.303.CLAC42Z.pdf

Model Series Insert Config. Housing Insulator Contact Collet Type Cable Ø Variant
FFA.3S.303.CLAC42Z

<p>Datasheet</p>	<p>Straight plug, cable collet and nut for fitting a bend relief</p> <p>Series 3S</p>		<p>Drawn 03.04.2024 MARI / MARI</p>
	<p>LEMO</p> <p>LEMO SA Chemin des Champs-Courbes 28 1024 Ecublens - SWITZERLAND</p>		<p>Checked 03.04.2024 OBAR</p>
	<p>Tel. (+41 21) 695 16 00 email : info@lemo.com www.lemo.com</p>		<p>Modified 00 03.04.2024 / MARI</p>
	<p>CD</p>		<p>DO NOT SCALE DRAWING</p>
<p>FFA.3S.303.CLAC42Z</p>			