

All dimensions are in millimeters (mm)

Alignment Key
Front View

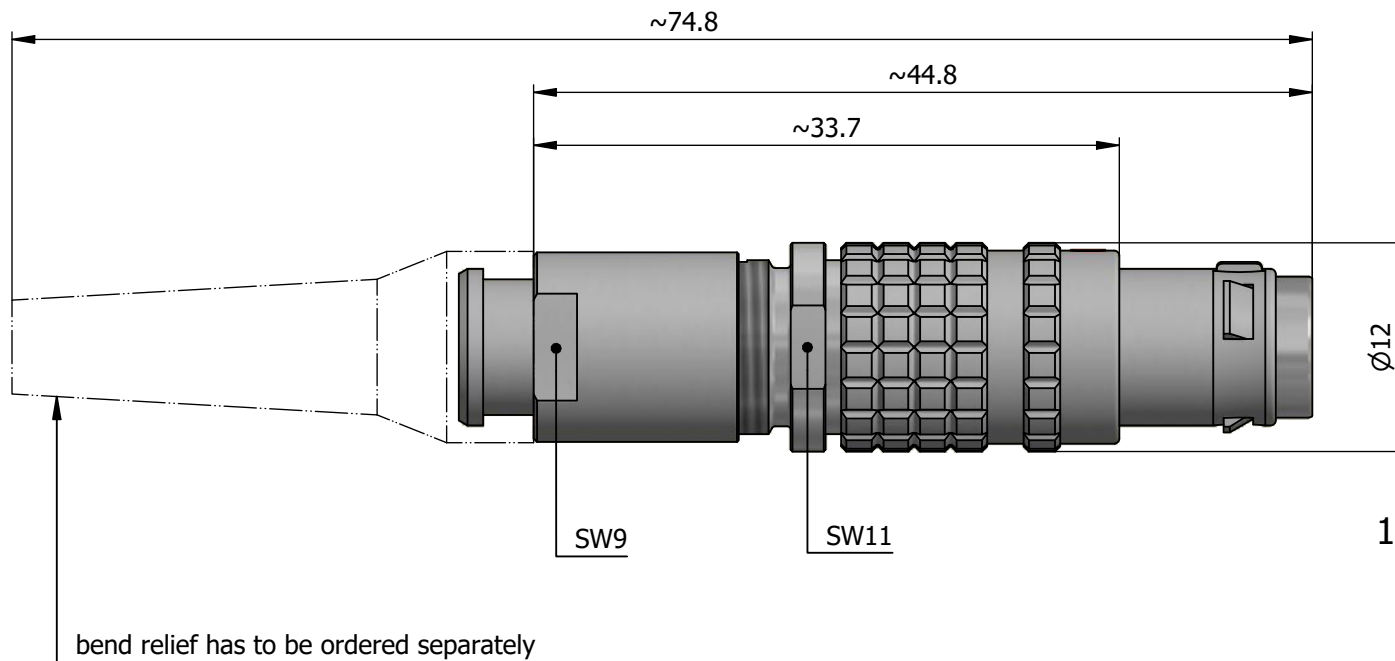

Insert Configuration
Rear View

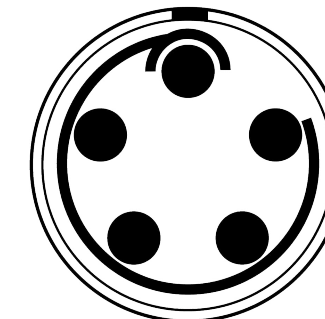

Note:

1) This picture is generic and for illustrative purposes only, and may show different keying, materials, colour, finish, and contact configuration. Minor shape or feature variations to actual item may be present.

All additional information are documented on the datasheet (See below link or QR Code)
www.lemo.com/pdf/FGG.1T.305.CLAC65Z.pdf

Model	Alignment Key	Series	Insert Config.	Housing	Insulator	Contact	Collet Type	Cable Ø	Variant
FGG	.1T	.305	.CLAC	65Z					

Datasheet



Straight plug, cable collet and nut for fitting a bend relief

Series 1T

LEMO
 LEMO SA
 Chemin des Champs-Courbes 28
 1024 Ecublens - SWITZERLAND

Tel. (+41 21) 695 16 00
 email : info@lemo.com
 www.lemo.com

CD

Drawn	08.02.2022	MARI / MARI
Checked	08.02.2022	OBAR
Modified	00	08.02.2022 / MARI
DO NOT SCALE DRAWING		

FGG.1T.305.CLAC65Z