

All dimensions are in millimeters (mm)

Alignment Key
Front View

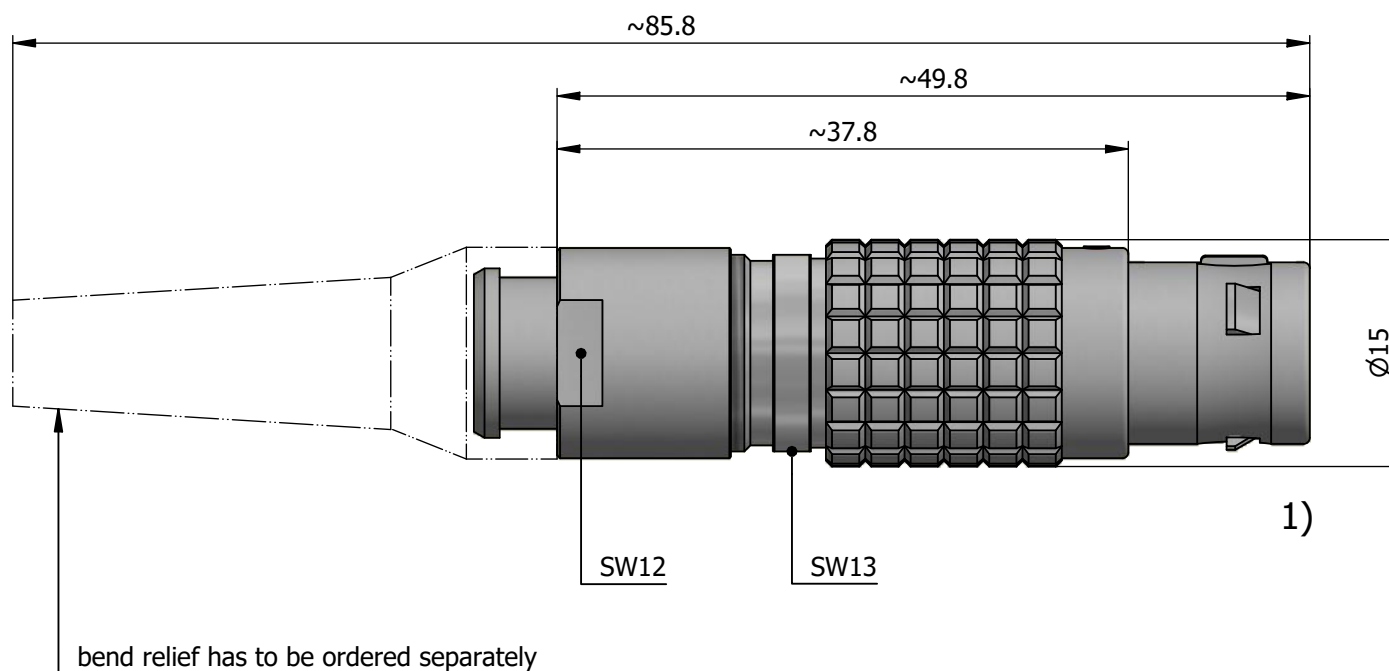

Insert Configuration
Rear View



Note:

1) This picture is generic and for illustrative purposes only, and may show different keying, materials, colour, finish, and contact configuration. Minor shape or feature variations to actual item may be present.

All additional information are documented on the datasheet (See below link or QR Code)
www.lemo.com/pdf/FGG.2B.316.CLAD92Z.pdf

Model	Alignment Key	Series	Insert Config.	Housing	Insulator	Contact	Collet Type	Cable Ø	Variant
FGG	.2B	.316	.CLAD92Z						

	Straight plug, cable collet and nut for fitting a bend relief Series 2B		Drawn 25.11.2021 MARI/MARI
	 LEMO SA Chemin des Champs-Courbes 28 1024 Ecublens - SWITZERLAND		Checked 25.11.2021 OBAR
	Tel. (+41 21) 695 16 00 email : info@lemo.com www.lemo.com		Modified 01 25.11.2021/MARI
	CD		DO NOT SCALE DRAWING

FGG.2B.316.CLAD92Z