

All dimensions are in millimeters (mm)

Alignment Key
Front View

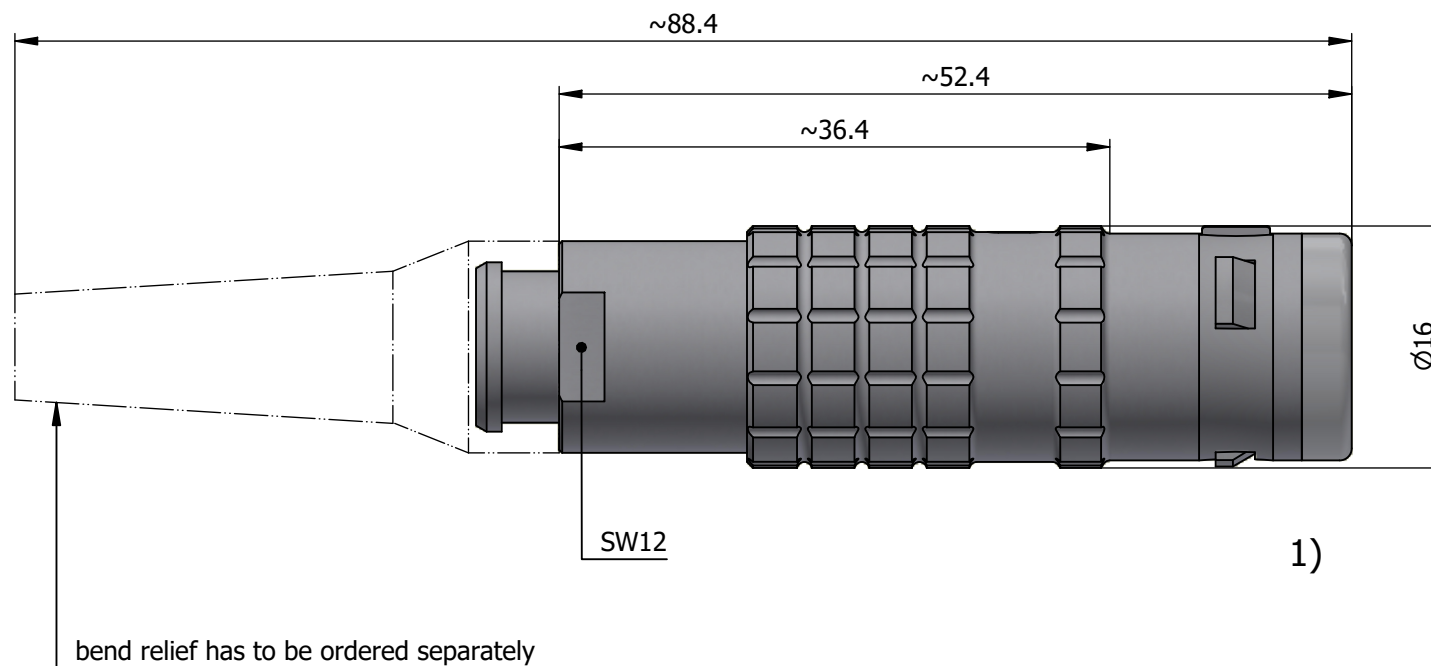

Insert Configuration
Rear View

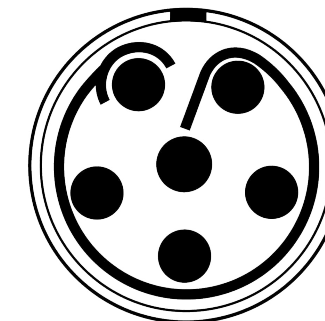

Note:

1) This picture is generic and for illustrative purposes only, and may show different keying, materials, colour, finish, and contact configuration. Minor shape or feature variations to actual item may be present.

All additional information are documented on the datasheet (See below link or QR Code)
www.lemo.com/pdf/FGG.2K.306.CLAC35Z.pdf

Model	Alignment Key	Series	Insert Config.	Housing	Insulator	Contact	Collet Type	Cable Ø	Variant
FGG	.2K	.306	.CLAC35Z						

Datasheet



Straight plug, cable collet and nut for fitting a bend relief
 Series 2K

LEMO
 LEMO SA
 Chemin des Champs-Courbes 28
 1024 Ecublens - SWITZERLAND

Tel. (+41 21) 695 16 00
 email : info@lemo.com
 www.lemo.com

CD

Drawn	22.09.2017	OVU / NHA
Checked	17.07.2024	CDE
Modified	01	17.07.2024 / MARI
DO NOT SCALE DRAWING		

FGG.2K.306.CLAC35Z