

All dimensions are in millimeters (mm)

Alignment Key  
Front View

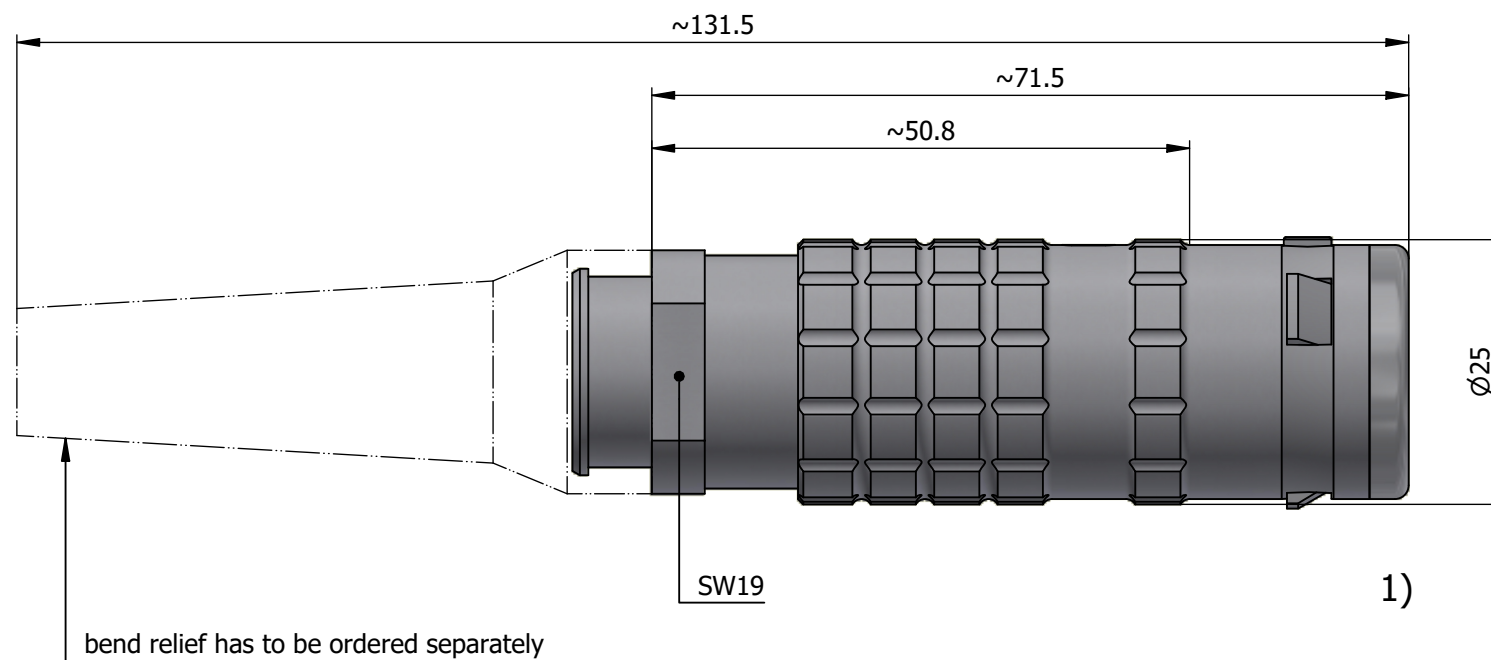

Insert Configuration  
Rear View



**Note:**

1) This picture is generic and for illustrative purposes only, and may show different keying, materials, colour, finish, and contact configuration. Minor shape or feature variations to actual item may be present.

All additional information are documented on the datasheet (See below link or QR Code)  
[www.lemo.com/pdf/FGG.4K.316.CLAC15Z.pdf](http://www.lemo.com/pdf/FGG.4K.316.CLAC15Z.pdf)

Model	Alignment Key	Series	Insert Config.	Housing	Insulator	Contact	Collet Type	Cable Ø	Variant
FGG	.4K	.316	.CLAC	15Z					

Datasheet



**Straight plug, cable collet and nut for fitting a bend relief**

Series 4K

**LEMO**  
 LEMO SA  
 Chemin des Champs-Courbes 28  
 1024 Ecublens - SWITZERLAND

Tel. (+41 21) 695 16 00  
 email : info@lemo.com  
 www.lemo.com

CD

Drawn	16.08.2024	MARI / MARI
Checked	16.08.2024	OBAR
Modified	00	16.08.2024 / MARI
DO NOT SCALE DRAWING		

**FGG.4K.316.CLAC15Z**