

All dimensions are in millimeters (mm)

Alignment Key  
Front View

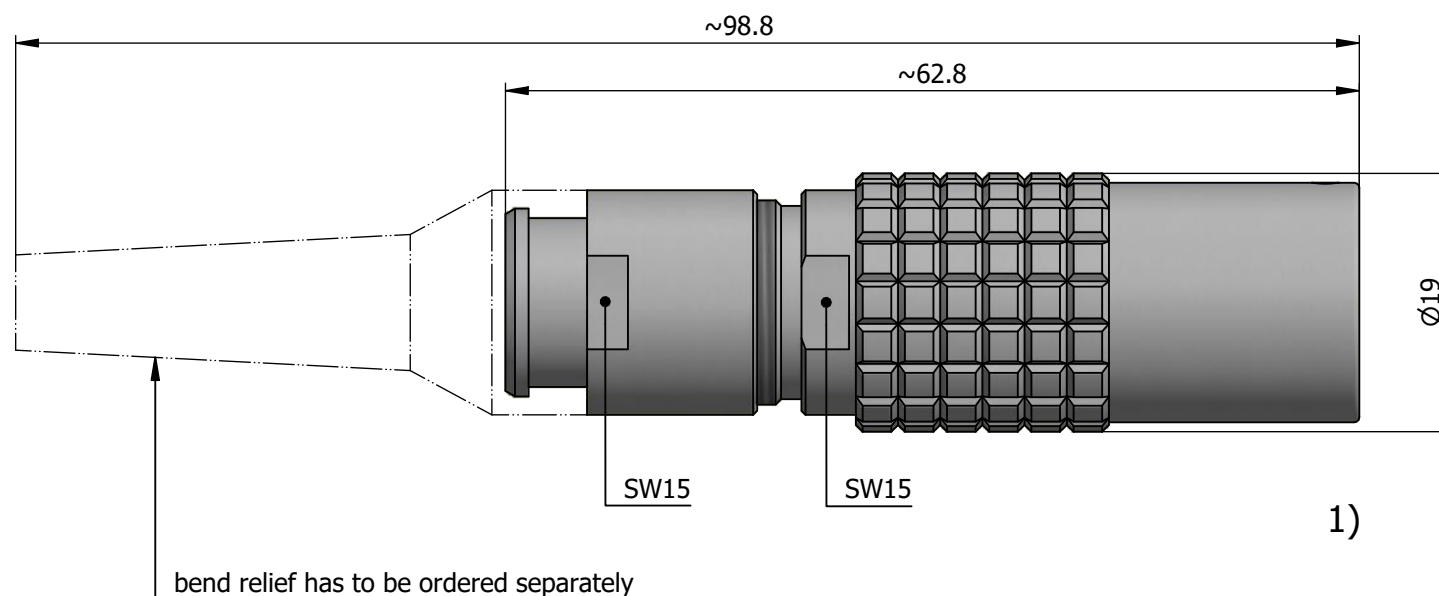

Insert Configuration  
Rear View

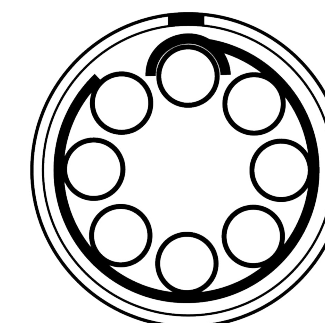

**Note:**

1) This picture is generic and for illustrative purposes only, and may show different keying, materials, colour, finish, and contact configuration. Minor shape or feature variations to actual item may be present.

All additional information are documented on the datasheet (See below link or QR Code)  
[www.lemo.com/pdf/PHG.3B.308.CYMD92Z.pdf](http://www.lemo.com/pdf/PHG.3B.308.CYMD92Z.pdf)

Model	Alignment Key	Series	Insert Config.	Housing	Insulator	Contact	Collet Type	Cable Ø	Variant
PHG	.3B	.308	.CYMD92Z						

Datasheet



**Free socket, cable collet and nut for fitting a bend relief**

Series 3B

**LEMO**  
 LEMO SA  
 Chemin des Champs-Courbes 28  
 1024 Ecublens - SWITZERLAND

Tel. (+41 21) 695 16 00  
 email : info@lemo.com  
 www.lemo.com

CD

Drawn	10.06.2011	OVU / JPBA
Checked	08.07.2022	MARI
Modified	01	08.07.2022 / MARI
DO NOT SCALE DRAWING		

**PHG.3B.308.CYMD92Z**