

All dimensions are in millimeters (mm)

Alignment Key
Front View

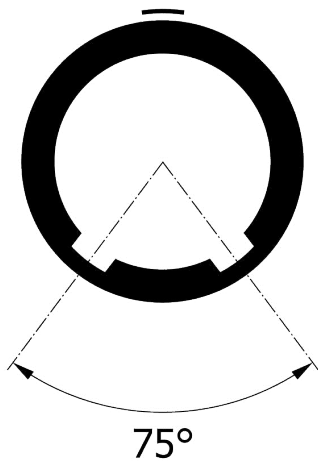

Insert Configuration
Rear View

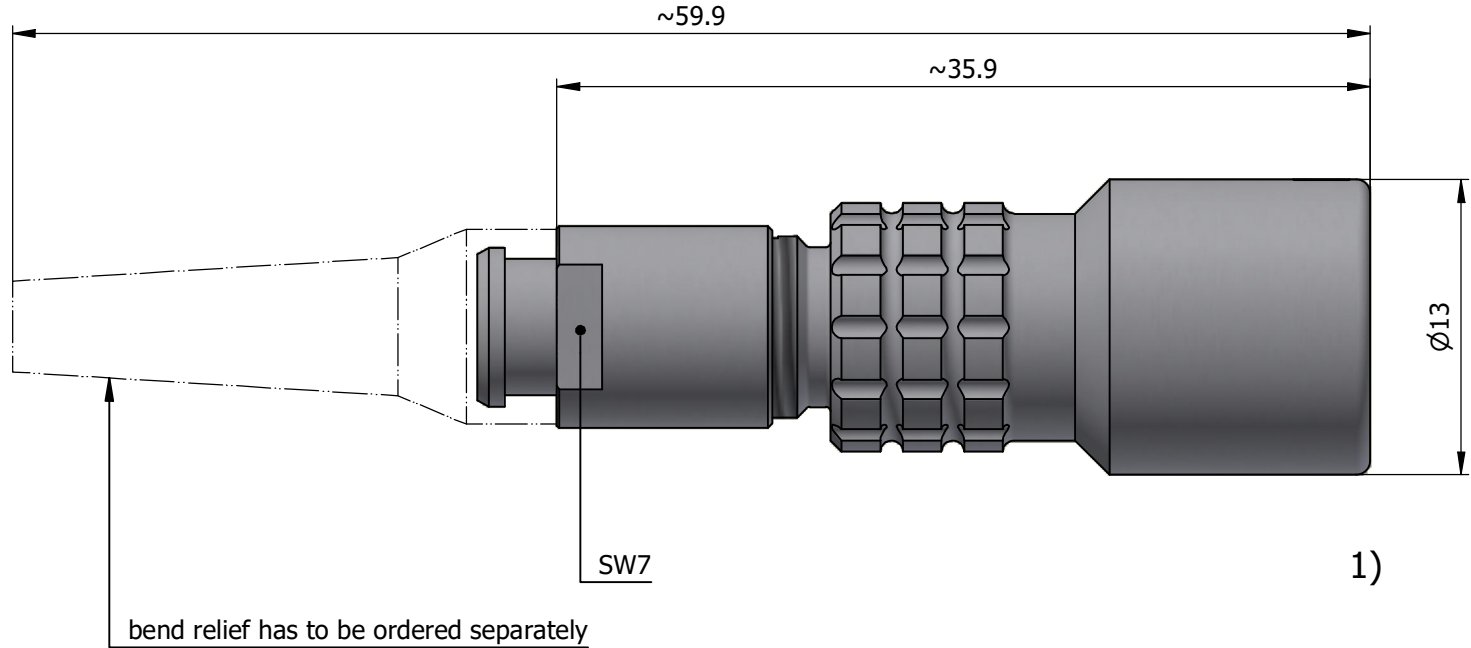
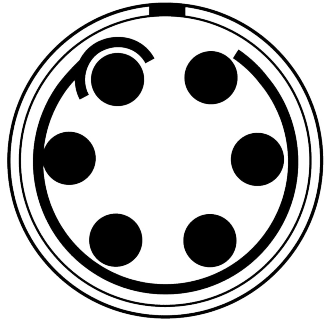

Note:

1) This picture is generic and for illustrative purposes only, and may show different keying, materials, colour, finish, and contact configuration. Minor shape or feature variations to actual item may be present.

All additional information are documented on the datasheet (See below link or QR Code)
www.lemo.com/pdf/PHL.OK.306.KLAC45Z.pdf

Model	Alignment Key	Series	Insert Config.	Housing	Insulator	Contact	Collet Type	Cable Ø	Variant
PHL	.OK	.306	.KLAC45Z						

<p>Datasheet</p>	<p>Free socket, cable collet and nut for fitting a bend relief</p> <p>Series OK</p>		<p>Drawn 19.12.2024 MARI/MARI</p>
	<p>LEMO</p> <p>LEMO SA Chemin des Champs-Courbes 28 1024 Ecublens - SWITZERLAND</p>		<p>Checked 19.12.2024 OBAR</p>
	<p>Tel. (+41 21) 695 16 00 email : info@lemo.com www.lemo.com</p>		<p>Modified 00 19.12.2024/MARI</p>
<p>CD</p>			<p>DO NOT SCALE DRAWING</p>
<p>PHL.OK.306.KLAC45Z</p>			