

All dimensions are in millimeters (mm)

Alignment Key
Front View

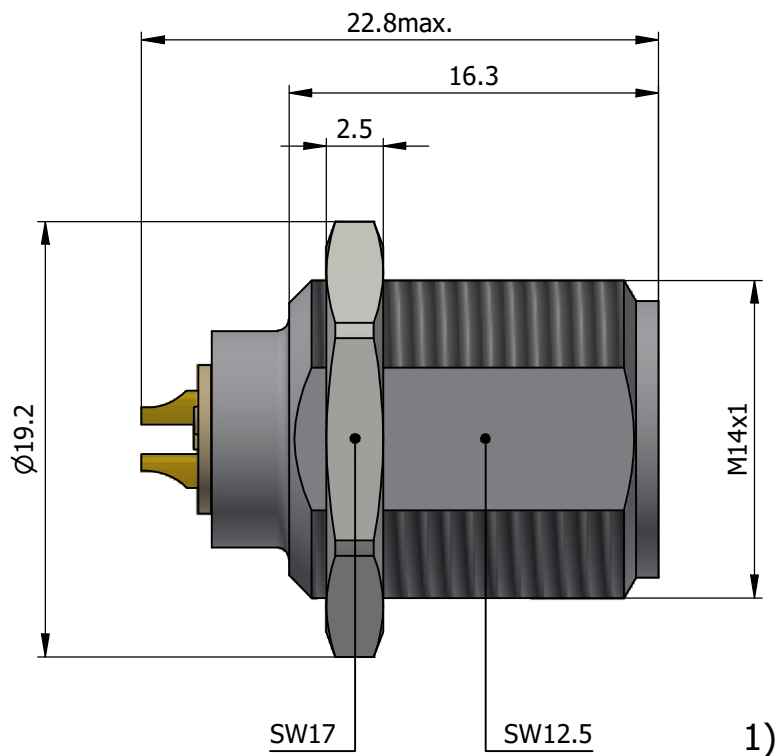

Insert Configuration
Rear View

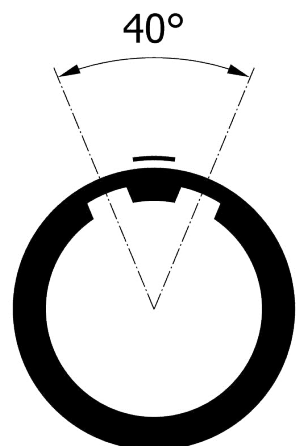
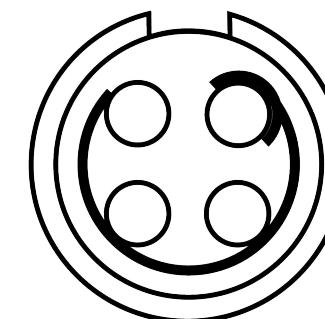

Recommended Panel Cut-Out

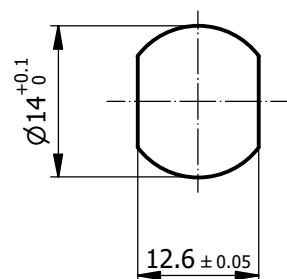

Mounting nut torque (Nm)
Plastic shell = 1.5

Note:

1) This picture is generic and for illustrative purposes only, and may show different keying, materials, colour, finish, and contact configuration. Minor shape or feature variations to actual item may be present.

All additional information are documented on the datasheet (See below link or QR Code)
www.lemo.com/pdf/PKA.M0.4GL.LZ.pdf

Model Alignment Key
Insert Config.
Housing Insulator
Contact Front Nut Color
PKA.M0.4GL.LZ

Datasheet



Fixed socket, without front nut (back panel mounting)
Series 1P

LEMO SA
Chemin des Champs-Courbes 28
1024 Ecublens - SWITZERLAND
Tel. (+41) 21 695 16 00
email : info@lemo.com
www.lemo.com

CD

Drawn	12.04.2023	MARI / MARI
Checked	02.12.2024	OBAR
Modified	01	02.12.2024 / JMIG
DO NOT SCALE DRAWING		

PKA.M0.4GL.LZ