

All dimensions are in millimeters (mm)

Alignment Key
Front View

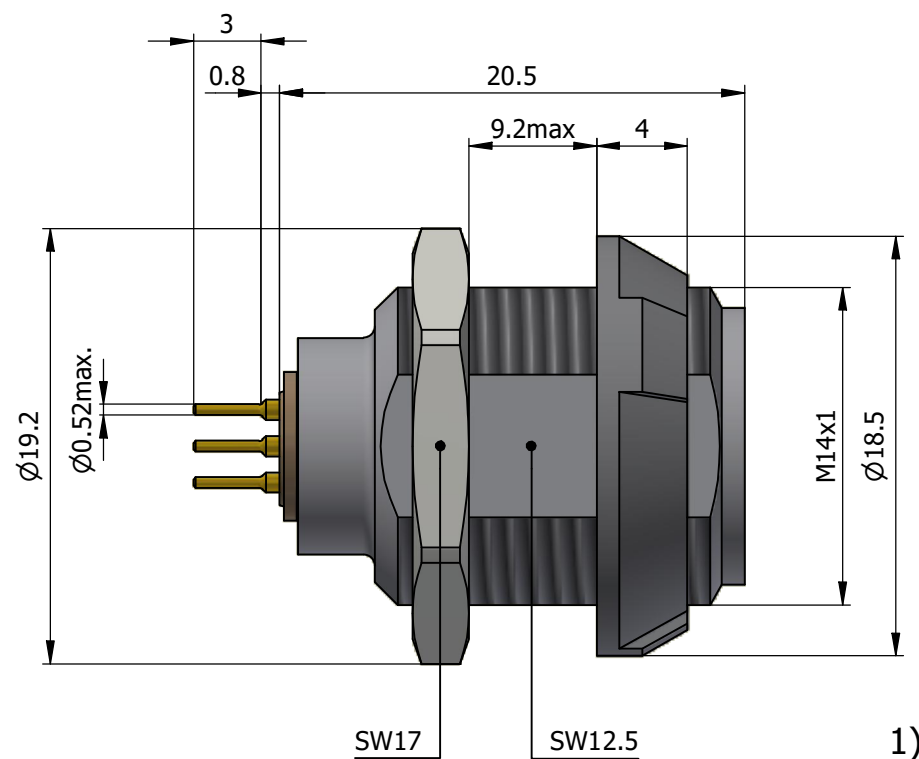

Insert Configuration
Rear View

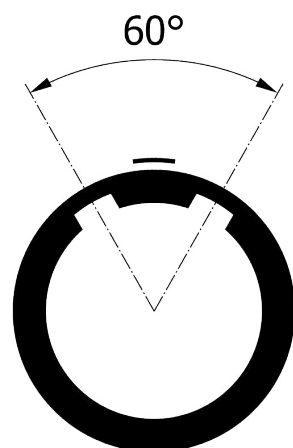
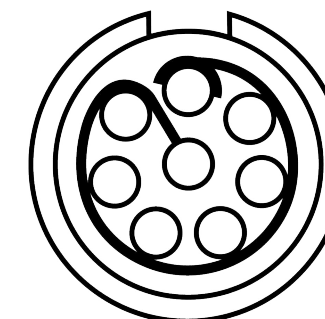

Recommended Panel Cut-Out

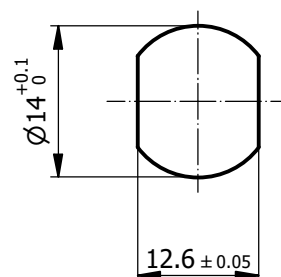

Mounting nut torque (Nm)
Plastic shell = 1.5

Recommended PCB Layout
PCB Top View

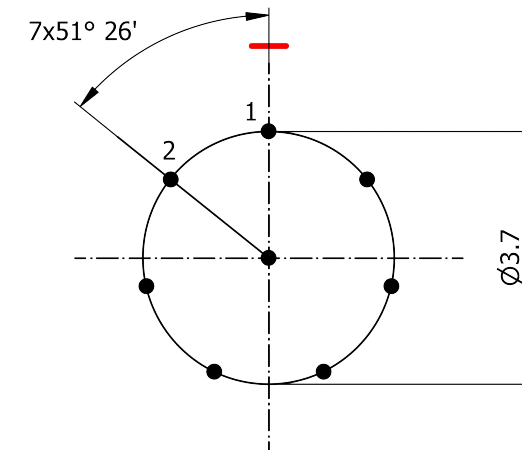

Note:

1) This picture is generic and for illustrative purposes only, and may show different keying, materials, colour, finish, and contact configuration. Minor shape or feature variations to actual item may be present.

All additional information are documented on the datasheet (See below link or QR Code)
www.lemo.com/pdf/PKB.M0.8GL.NR.pdf

Model Alignment Key Insert Config. Housing Insulator Contact Front Nut Color
PKB.M0.8GL.NR

Datasheet



Fixed socket, with two nuts, for PCB (back panel mounting)

Series 1P

LEMO
LEMO SA
Chemin des Champs-Courbes 28
1024 Ecublens - SWITZERLAND

Tel. (+41) 21 695 16 00
email : info@lemo.com
www.lemo.com

CD

Drawn	05.04.2023	MARI / MARI
Checked	19.01.2026	OBAR
Modified	02	19.01.2026 / MARI
DO NOT SCALE DRAWING		

PKB.M0.8GL.NR