

All dimensions are in millimeters (mm)

Alignment Key  
Front View

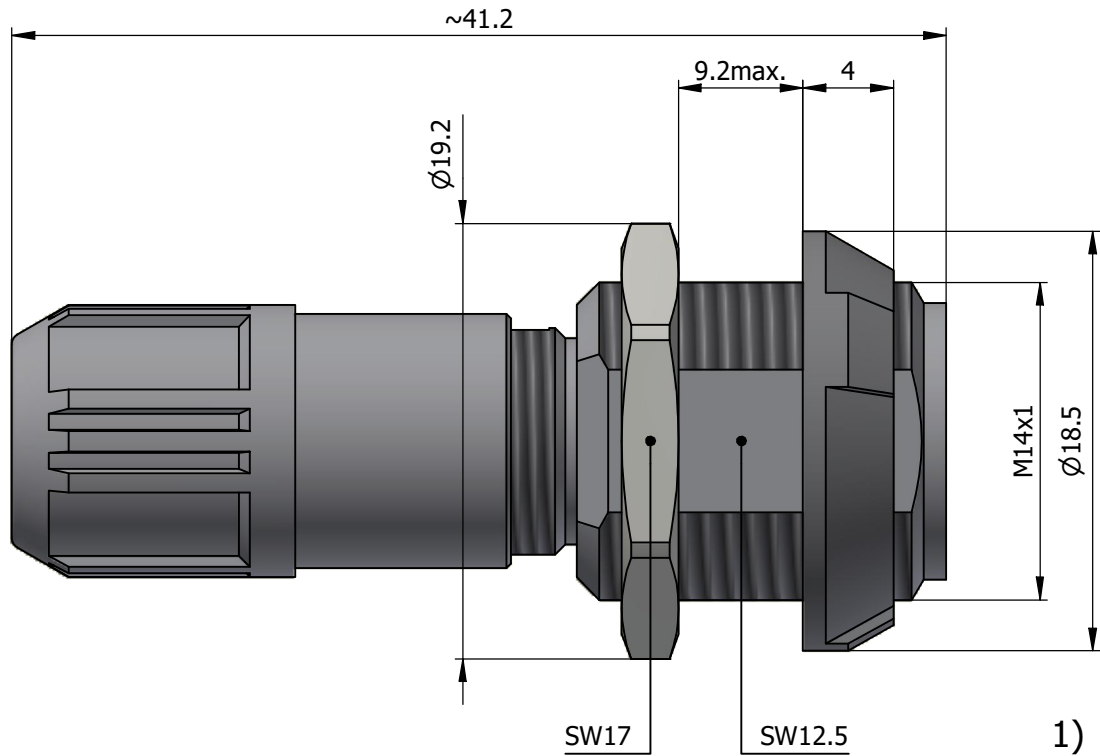

Insert Configuration  
Rear View

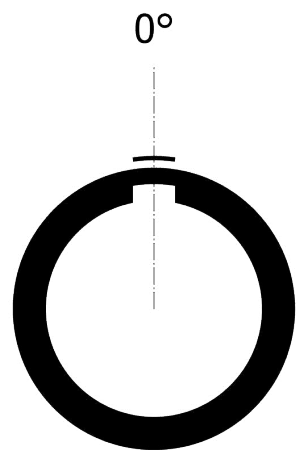
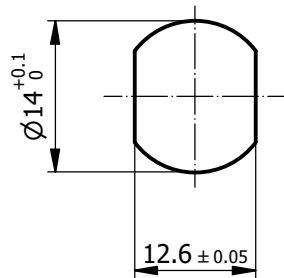
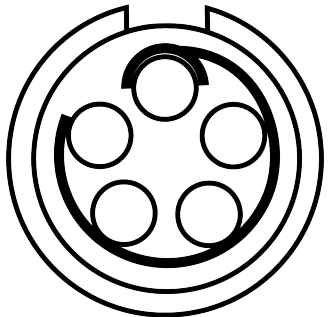



Mounting nut torque (Nm)  
Plastic shell = 1.5

**Note:**

1) This picture is generic and for illustrative purposes only, and may show different keying, materials, colour, finish, and contact configuration. Minor shape or feature variations to actual item may be present.

All additional information are documented on the datasheet (See below link or QR Code)  
[www.lemo.com/pdf/PTG.M0.5GL.LC65G.pdf](http://www.lemo.com/pdf/PTG.M0.5GL.LC65G.pdf)

Model Alignment Key Insert Config. Housing Insulator Contact Collet Type Cable Ø Front Nut Color Variant  
**PTG.M0.5GL.LC65G**

	<b>Fixed socket, cable collet</b> Series 1P		Drawn 12.11.2024 MARI/MARI
	 REDEL Redel SA Rue du canal 2 1450 Ste-Croix - SWITZERLAND		Checked 12.11.2024 OBAR
	Tel. (+41 24) 455 25 00 Fax. (+41 24) 455 25 01		Modified 00 12.11.2024/MARI
	CD		DO NOT SCALE DRAWING
<b>PTG.M0.5GL.LC65G</b>			