

All dimensions are in millimeters (mm)

Alignment Key
Front View

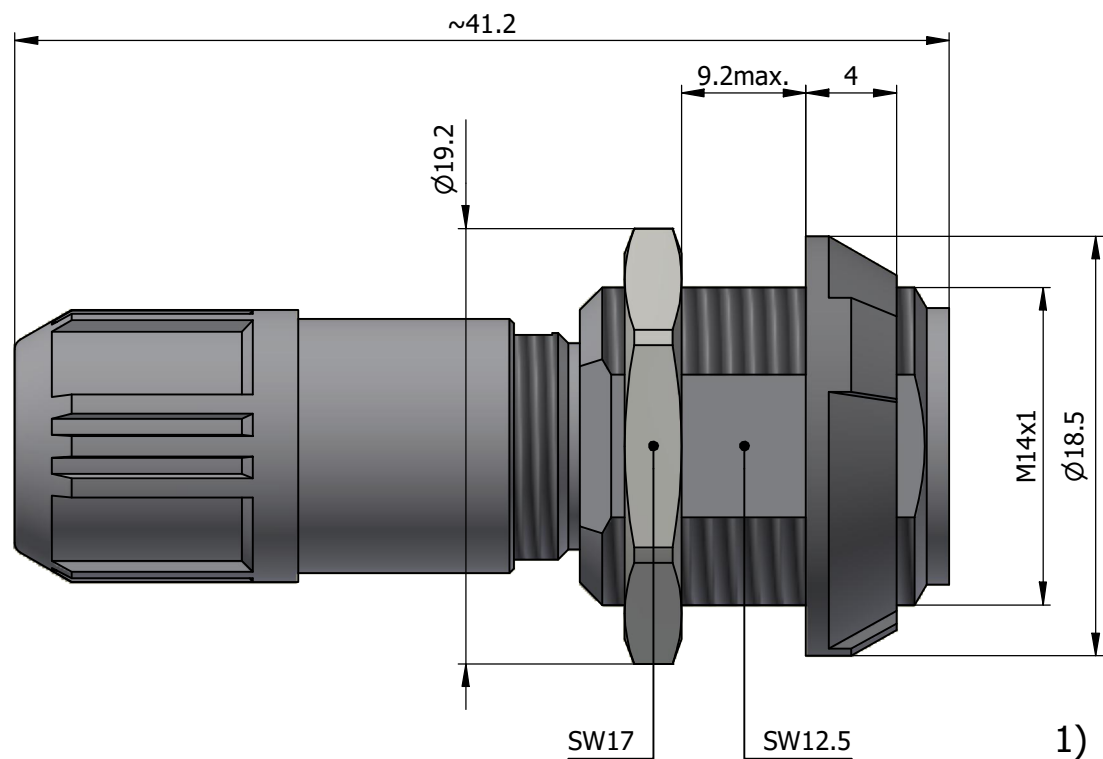

Insert Configuration
Rear View

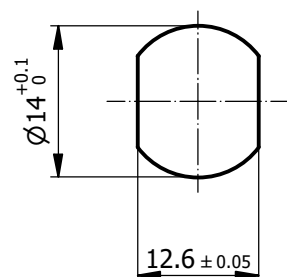
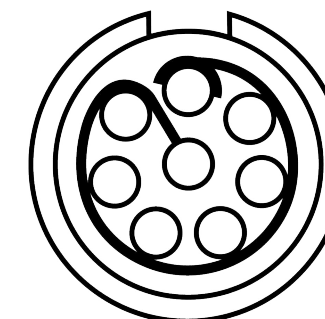

Mounting nut torque (Nm)
Plastic shell = 1.5

Note:

1) This picture is generic and for illustrative purposes only, and may show different keying, materials, colour, finish, and contact configuration. Minor shape or feature variations to actual item may be present.

All additional information are documented on the datasheet (See below link or QR Code)
www.lemo.com/pdf/PTG.M0.8GL.LC52G.pdf

Model Alignment Key Insert Config. Housing Insulator Contact Collet Type Cable Ø Front Nut Color Variant
PTG.M0.8GL.LC52G

Datasheet



Fixed socket, cable collet

Series 1P



Redel SA
Rue du canal 2
1450 Ste-Croix - SWITZERLAND

Tel. (+41 24) 455 25 00
Fax. (+41 24) 455 25 01

CD

Drawn	12.11.2024	MARI/MARI
Checked	12.11.2024	OBAR
Modified	00	12.11.2024/MARI
DO NOT SCALE DRAWING		

PTG.M0.8GL.LC52G