

All dimensions are in millimeters (mm)

Alignment Key
Front View

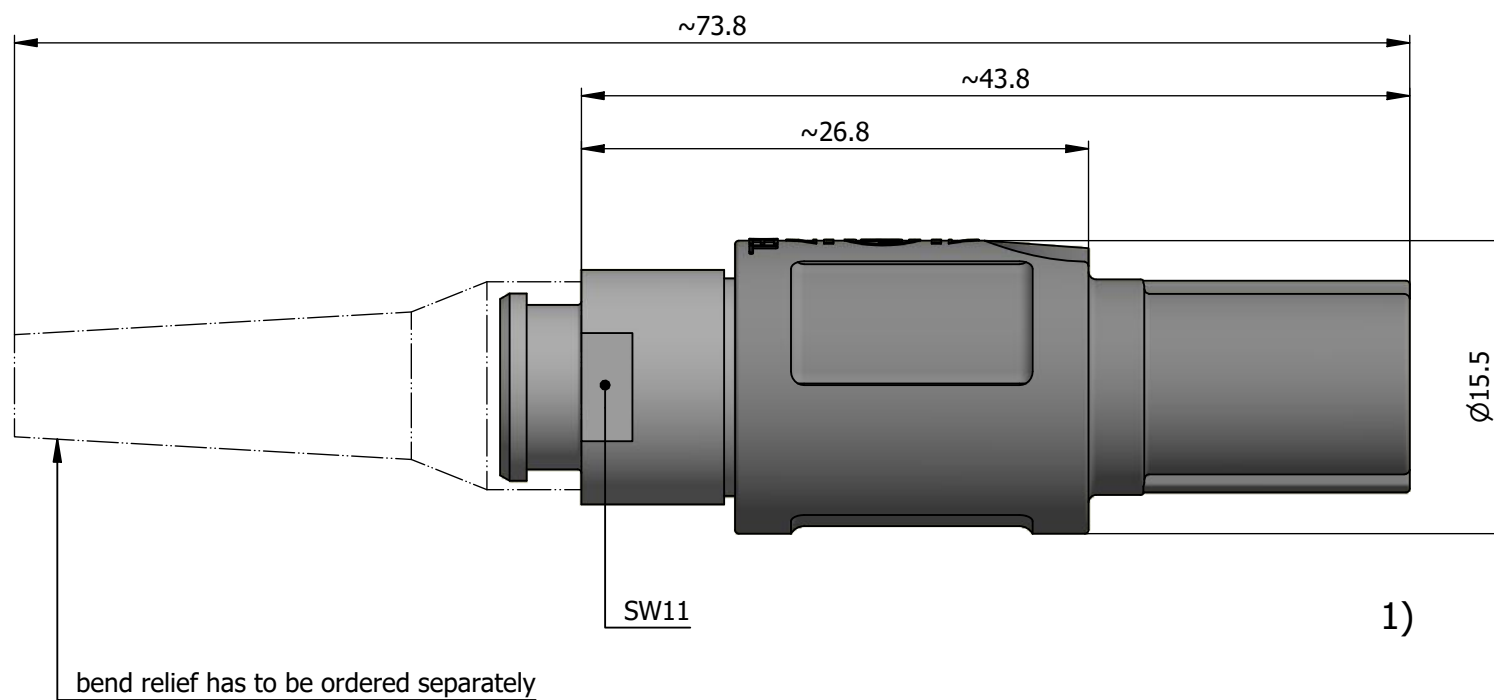

Insert Configuration
Rear View

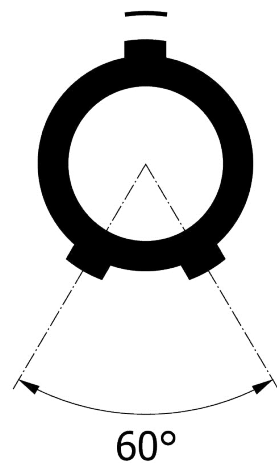
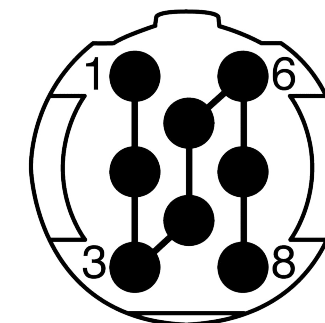

Note:

1) This picture is generic and for illustrative purposes only, and may show different keying, materials, colour, finish, and contact configuration. Minor shape or feature variations to actual item may be present.

All additional information are documented on the datasheet (See below link or QR Code)
www.lemo.com/pdf/SAP.M08.NLB.3NZ.pdf

Model
SAP.M08.NLB.3NZ

Alignment Key

Insert Config.

Outershell Color
Insulator
Contact

Collet Size
Collet Nut Color
Variant

Datasheet



Straight plug, cable collet and nut for fitting a bend relief

SP Series



Redel SA
Rue du canal 2
1450 Ste-Croix - SWITZERLAND

Tel. (+41 24) 455 25 00
Fax. (+41 24) 455 25 01

CD

Drawn	26.08.2022	MARI / MARI
Checked	26.08.2022	OBAR
Modified	00	26.08.2022 / MARI
DO NOT SCALE DRAWING		

SAP.M08.NLB.3NZ