

All dimensions are in millimeters (mm)

Insert Configuration  
Front View

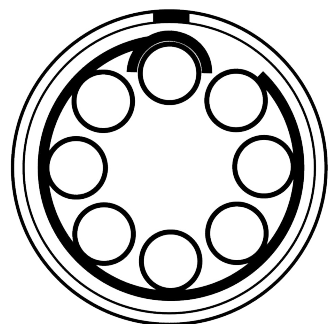

Insert Configuration  
Rear View

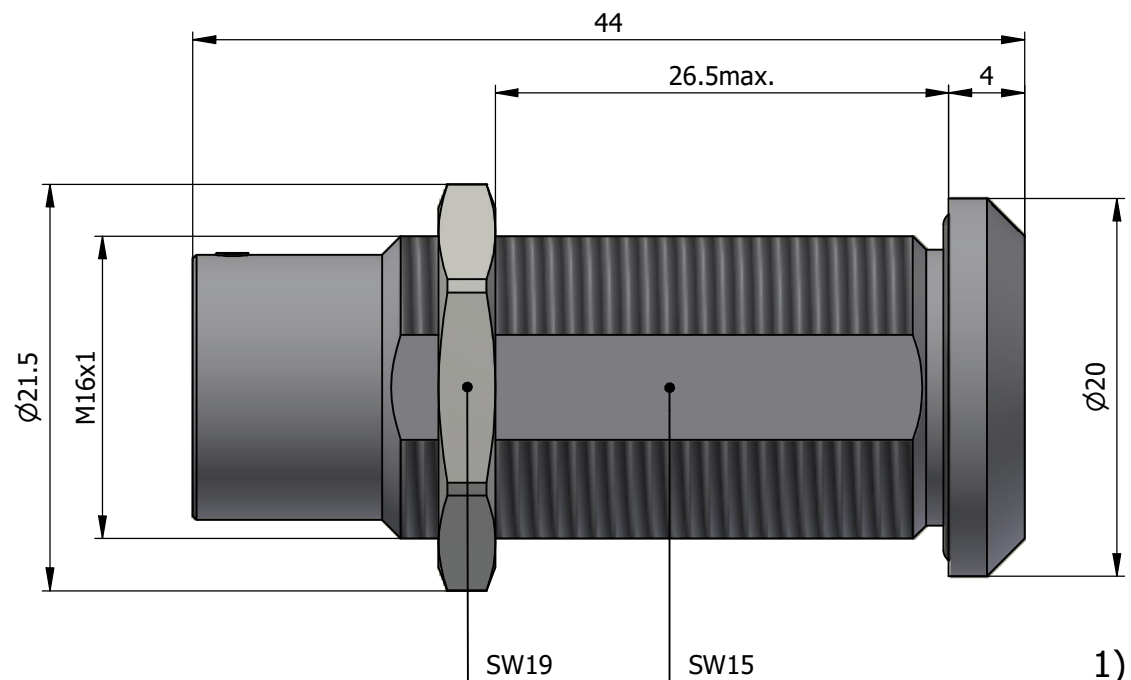
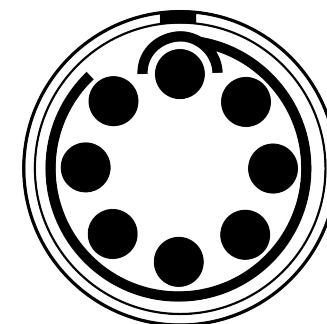

Alignment Key  
Front View

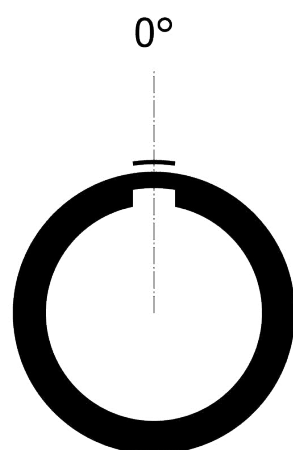

Alignment Key  
Rear View

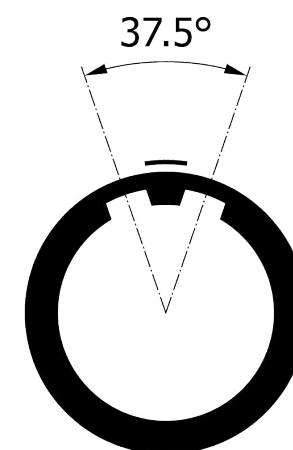

Recommended Panel Cut-Out

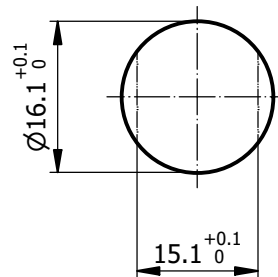

Mounting nut torque (Nm)  
Metal shell = 6.0  
Plastic shell = 0.8

**Note:**

1) This picture is generic and for illustrative purposes only, and may show different keying, materials, colour, finish, and contact configuration. Minor shape or feature variations to actual item may be present.

All additional information are documented on the datasheet (See below link or QR Code)  
[www.lemo.com/pdf/SGJ.2B.308.CLLP.pdf](http://www.lemo.com/pdf/SGJ.2B.308.CLLP.pdf)

Model Alignment Key Series Insert Config. Housing Insulator Contact Variant  
SGJ . 2B . 308 . CLLP

Datasheet



**Fixed coupler, nut fixing**

Series 2B

**LEMO**  
LEMO SA  
Chemin des Champs-Courbes 28  
1024 Ecublens - SWITZERLAND

Tel. (+41 21) 695 16 00  
email : info@lemo.com  
www.lemo.com

CD

Drawn	18.12.2024	MARI / MARI
Checked	18.12.2024	OBAR
Modified	00	18.12.2024 / MARI
DO NOT SCALE DRAWING		

**SGJ.2B.308.CLLP**