

All dimensions are in millimeters (mm)

Insert Configuration
Front View

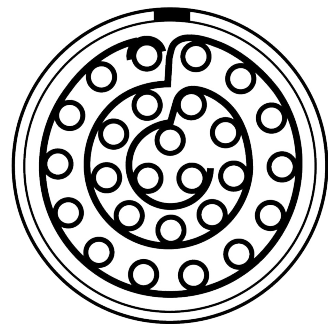

Insert Configuration
Rear View

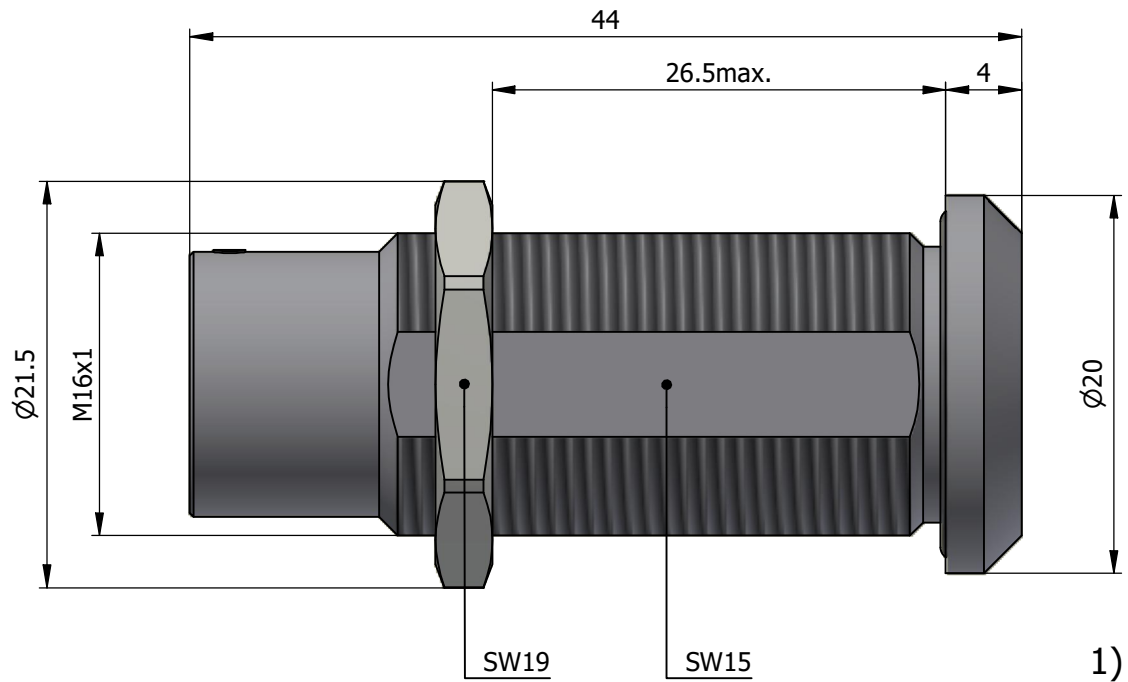
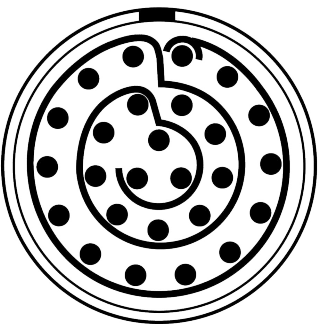

Alignment Key
Front View

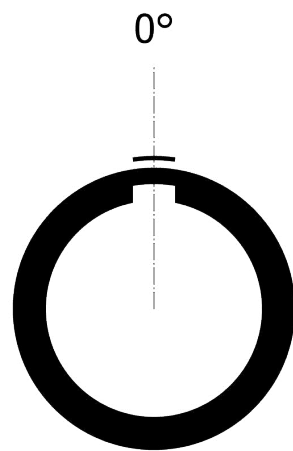

Alignment Key
Rear View

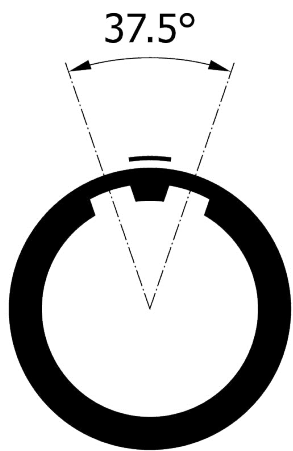

Recommended Panel Cut-Out

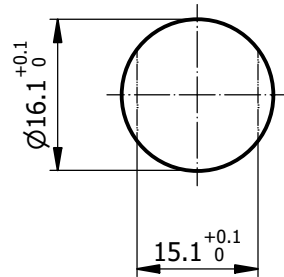

Mounting nut torque (Nm)
Metal shell = 6.0
Plastic shell = 0.8

Note:

1) This picture is generic and for illustrative purposes only, and may show different keying, materials, colour, finish, and contact configuration. Minor shape or feature variations to actual item may be present.

All additional information are documented on the datasheet (See below link or QR Code)
www.lemo.com/pdf/SGJ.2B.326.CLLPV.pdf

Model Alignment Key Series Insert Config. Housing Insulator Contact Variant
SGJ . 2B . 326 . CLLPV

Datasheet



Fixed coupler, nut fixing
Series 2B

LEMO
LEMO SA
Chemin des Champs-Courbes 28
1024 Ecublens - SWITZERLAND

Tel. (+41 21) 695 16 00
email : info@lemo.com
www.lemo.com

CD

Drawn	18.12.2024	MARI / MARI
Checked	18.12.2024	OBAR
Modified	00	18.12.2024 / MARI
DO NOT SCALE DRAWING		

SGJ.2B.326.CLLPV